



GB Guldmann mobile lifter

Vers. 2.00

CE



Guldmann™

Guldmann mobile lifter

Item nos:

11220-xxx

11230-xxx

11240-xxx

1.00	Purpose and Use	3
1.01	Manufacturer	3
1.02	Purpose and Use of Hoist	3
1.03	Important/warning	5
1.04	Unpacking and preparation of the hoist	5
1.05	Assembling hoist before use	6
2.00	Description of Functions	7
2.01	Pictograms/labels	7
2.02	Operating mobile hoist GL2, 3 and 4	9
2.03	Safety functions	9
2.04	Recharging/connecting the hoist	10
2.05	Connection of charger	11
2.06	Accessories for the hoist	11
3.00	Dismantling and Transport	11
3.01	Dismantling the hoist	11
3.02	How to transport the hoist?	11
3.03	How to package the hoist for transport?	11
4.00	Maintenance and storage	12
4.01	Cleaning the hoist	12
4.02	Storing	12
4.03	Long-term storage	12
4.04	How to prevent/avoid corrosion?	12
4.05	Maintenance which should be carried out by the owner?	12
5.00	Service and Life Span	13
5.01	Life span and servicing of hoist	13
5.02	Battery and fuses	13
5.03	Troubleshooting	14
5.04	Service check of the mobile hoist – Allround	14
6.00	Technical Specifications	16
7.00	EC-Declaration of Conformity	17

1.00 Purpose and Use

1.01 Manufacturer

V. Guldmann A/S
Graham Bells Vej 21-23A
DK - 8200 Århus N
Tel. +45 8741 3100
Fax. +45 8741 3131

1.02 Purpose and Use of Hoist**Purpose**

The Guldmann mobile hoist is a carefully designed, all-round hoist which covers the needs of hospitals, nursing homes, institutions and private homes. It can be used wherever elderly and handicapped people have to be lifted or moved. The hoist is equipped with Guldmann's padded lifting hanger made of rustproof materials. It should be used at an approximate maximum of walking speed. Accessories consist of Guldmann's lifting slings in various sizes and models.

Requirements

When a hoist is used in an institution or in the home care service, the assumption is that it will be operated by qualified staff.
Use slings with 4-6 lifting straps designed for use with hooks of min. Ø 8 mm.

Lifting to and from a sitting position

When lifting from e.g. a wheelchair, move the hoist towards the person to be lifted. Lifting boom and lifting hanger should be level with the chest and positioned above the middle of the thigh.

Position lifting hanger parallel to the user's shoulders. Now fit the lifting sling to the lifting hanger. For instructions on how to fit the sling, see the section entitled "Fitting the lifting sling".

Lifting to and from a lying position in bed

Position lifting boom and lifting hanger right over the bed. Now pull the hoist back until the lifting boom and lifting hanger are positioned above the centre of the person to be lifted. The lifting hanger and lifting boom should be parallel with the person's shoulders. Now fit the lifting sling to the lifting hanger. For instructions on how to fit the sling, see section entitled "Fitting the lifting sling".

Working with the mobile hoist

To obtain a correct working posture when moving the hoist, the carer should always, by placing one leg in front of the other, push the hoist in a forward motion thus utilizing his/her body weight.

Turning the hoist should be carried out by two persons, otherwise, stand alongside the hoist and push on the side of the mast thereby minimising the centre of rotation. It is a good idea to make the heaviest point of the hoist the centre of rotation. If there is limited space, you can use your foot to push on the chassis of the hoist in the direction you wish to turn.

Fitting the lifting sling

Hook the top set of straps (from the back) to the hooks facing the user. Hook the lower set of straps (from the legs) to the hooks facing away from the user.

From a chair, wheelchair or other sitting positions

Place lifting sling behind user's back e.g. between the back of the chair and the user's back.

The centre band of the lifting sling should follow the user's spine. As for the slings type Active the strap showing the size of the sling should

be opposite the spine. Bring the leg straps along the outer thigh and then under the thigh between the back of the knee and the hip.

Now cross the leg straps in front of the user.

All four straps are now ready to be mounted onto the lifting hanger.

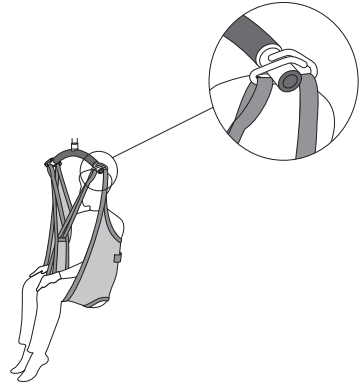

Lying position in bed, on a mattress or on the floor

Turn the user on his side. Place the high back sling so that its upper edge is flush with the top of the user's head. Put the sling on the user so that the centre band follows the spine. Turn the user on his back and pull the sling out. Bring the leg straps under the thigh and cross them over.

All four straps are now ready to be mounted onto the lifting hanger.

If in doubt about how to use the sling, please contact your supplier.

Guldmann cannot be held responsible for any faults or accidents that may occur due to incorrect positioning of the lifting hanger, or for reasons of inadequate attention paid by helpers or the user.

1.03

Important/warning

- Read the user manual fully before using the hoist.
- Do **not** exceed the max. load of 150 kg.
- Use the hoist to lift persons only.
- Use the hoist on an even and level surface only.
- Only use a lifting hanger approved for use with the hoist.
- Don't lift/turn the lifting hanger in vertical direction during the mounting of the straps of the sling.
- Do not use the hoist where there is a risk of considerable amounts of water continuously coming into direct contact with the hoist.
- When adjusting the legs of the hoist make sure that no persons stand close to the legs due to the risk of being jammed.
- Do not run the hoist into persons or objects.
- Exchange of lifting motor/actuator according to the manufacturer's instructions. See section 5.04, point 2
- In case of damage, do not use the hoist until authorised by qualified service staff or the Guldmann service team.

1.04

Unpacking and preparation of the hoist

Visual check of hoist

Should the packaging be damaged on receipt, each part of the hoist must be carefully examined for visible defects or deficiencies. In case of suspected damage, do not use the hoist until authorised by qualified service staff or the Guldmann Service Team.

Parts list:

- Push handle
- Lifting hanger
- Upper part/mast
- Hand control
- Holder for hand control
- Chassis
- Charger Allen key
M5 x 2

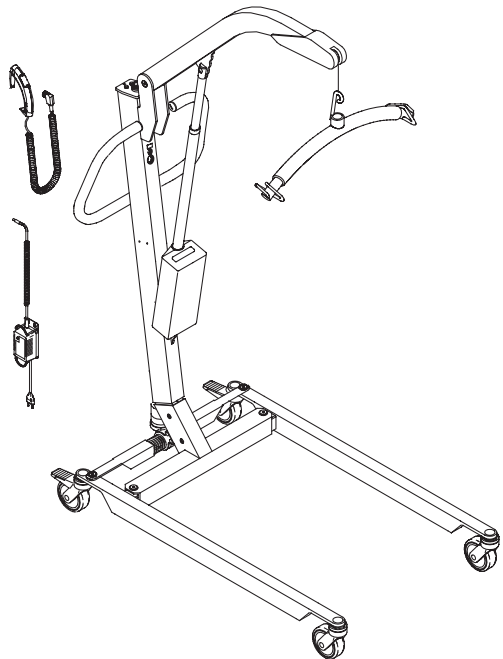

Assembling hoist before use**Assembling mast/chassis – electrical**

Loosen screw fitted to mast. Position mast in base. When mast is in as far as it will go, tighten screw using an M5 Allen key. To dismantle, remove screw to pull mast out of base.

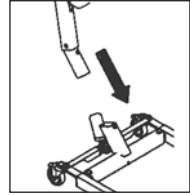
**Assembling steering lever and mast/chassis – manual**

Adjust legs outwards. Position mast in base. When mast is in as far as it will go, tighten the Allen screw. Bring the steering lever down over the steering lever plate and tighten.

Mounting of connectors for motors and hand control

Fit connectors for width adjustment motor, actuator and hand control in the mast.

Mounting of holder for hand control

Clean surfaces with the attached cleaning tissue. Remove the protective foil. Stick the holder on to the mast or the lifting boom of the mobile hoist. The holder is not ready to be used until after 3 days.

Fitting actuator

Fasten the actuator using the attached bushing and screw with nut. Tighten screw and nut and put on the nut protector.

Batteries

The batteries supplied with the hoist are not fully charged on delivery. Before use, therefore, the hoist must be charged up. A full charge, which takes about 8 hours, is recommended.

Fit lifting hanger to lifting boom as shown.

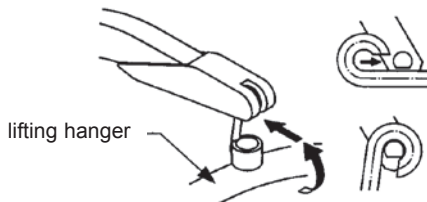





The hoist is now ready for use.

Label on mast of hoist

User Guide

HAND CONTROL

- Press  to lift
- Press  to lower
- Press  to open legs
- Press  to close legs

NB! Adjustment of legs is manual on Guldmann Mobile Hoist 2.

BRAKES

- Do *not* apply brakes when lifting and lowering.
- *Always* apply brakes when parking and lifting from a sloping surface

RECHARGING

- Recharge overnight or when not in use.
- Green battery indicator is on when hoist is in use.
- Recharging is urgently required when green indicator flashes. Hereafter hoist only allows 5 lifts.
- Charger switches off automatically.

REMEMBER TO TAKE THE MAINS PLUG OUT OF THE SOCKET BEFORE USING THE HOIST AGAIN.

AFTER USE, THE HOIST IS SWITCHED OFF AUTOMATICALLY.

IF THE HOIST DOES NOT STOP - PRESS 

IF THE HOIST DOES NOT LOWER - PRESS 

Always read user's manual before use.

| Time to care |

Labels in addition to that shown:

- Max. load

Example of a serial number label

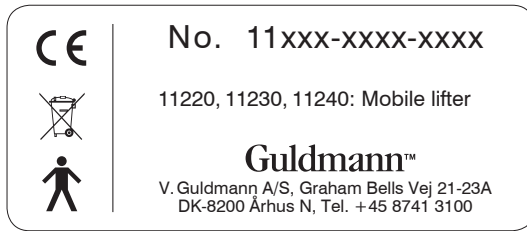

Warning label

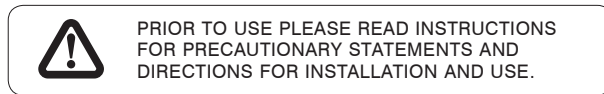

Label for charging input



CE-marking



Type B in accordance with EN 60601-1



Read instructions before use



Please don't throw away with household rubbish, but recycle the product

Hand control and indicator lamp

The hoist switches on automatically when pressing the hand control, and the green indicator lamp will light up when hoist is switched on (see illustration in "Recharging" section).

The hoist will switch off automatically approx. 1 min. after use.

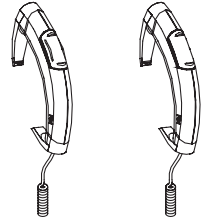

NB: If the emergency stop function has been activated, press the hand control twice.

Adjustment of chassis/width adjustment

- Adjusting the width of the mobile hoist GL2 chassis should be carried out as follows: stand alongside the hoist and pull/push handle to adjust chassis to the desired position.
- Use max. width setting when lifting to/from wide chairs, or as necessary when lifting to/from bed, toilet and floor.
- On mobile hoist GL3 and 4, chassis width is adjusted via the hand control.

Use of brakes

- The back castors are fitted with brakes. Apply the brake by pushing the brake pedal into the vertical position.
- To release the brake, push the brake pedal into the horizontal position.
- Do not apply brakes when lifting or lowering.
- Always apply brakes when parking.

Safety functions

Only use the emergency stop and emergency lowering functions in emergencies. Should it be necessary to apply the emergency/safety functions, the supplier must be contacted prior to using the hoist again.

**Activating the emergency stop function**

Should the hoist not respond to the functions selected on the hand control when it is in motion, **press emergency stop**.

When the emergency stop function is applied, the hoist ceases to function.

Switch the hoist on again by turning the emergency stop button in the direction of the arrow until it springs up. Press twice on the hand control and the hoist is ready for operation.

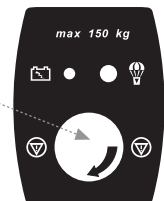



Activating the emergency lowering function

Should the hoist not lower

- **press emergency lowering.**

Continuous pressure on the red button "emergency lowering" ensures that the lifting boom is lowered even though the emergency stop is activated

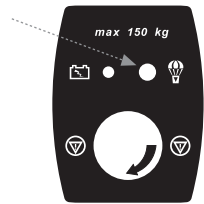

After having applied the emergency stop or the emergency lowering functions, the fault must be rectified prior to using the hoist again.

2.04

Recharging/connecting the hoist



Recharging

- Recharge by using the accompanying charging unit.
- Recharge hoist every night or when it is not in use. This maintains the batteries well and ensures a long life span.
- Recharging should be done when the green battery indicator lamp starts flashing.
- When the lamp starts flashing, there will be sufficient electricity for approx. 5 lifts after which the hoist will turn off automatically.
- The lamp on the charger lights up when it is in use.
- The charger will turn off automatically when hoist is fully recharged.
- Recharging must not take place in wet rooms/bathrooms.
- Max. recharging time is approx. 8 hours.

Charger

- The charger can be placed on the wall next to a socket or on the mast of the hoist thus always accompanying the hoist.
- The male connector of the charger can be connected to a short extension cable which can be fitted in the wall socket. If the male connector has not been removed from the extension cable when the lifter is moved, it will pull itself out of the extension cable without damaging any of the cables.

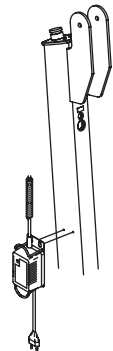

To safeguard the charger against incorrect use, a male connector, matching the mains supply system of the relevant country, has been fitted to the mains connection point, whereas the hoist connection point (24V DC) has been fitted with a female connector matching the hoist. The charger plug with the spiral cable is connected to the charger socket labelled 24V DC on the mast.

2.05 Connection of charger**Recharging in different areas**

Lift charger out of bracket and place on a dry surface. Connect charger plug to mains. Now insert the female connector into the hoist connection point for recharging. This point is labelled 24V DC.

Should you wish to recharge the hoist in different places, hang charger on the mast.

When charger is not in use, the mains cable should be wound round the charger bracket.

Permanent charging area

Should you wish to park and recharge the hoist in one place only, the charger can be mounted to the wall. Connect charger plug to mains socket.

Now connect female connector to hoist connection point for recharging. This point is labelled 24V DC.

When charger is not in use, the spiral cable should be wound round the charger bracket.

When the hoist has to be stored away, the charger should always be placed on the hoist.

2.06 Accessories for the hoist**Lifting slings**

Ask for special brochure from supplier or manufacturer.

3.00 Dismantling and Transport

3.01 Dismantling the hoist

When the mast is lifted out of the base, the plug from the actuator should always be connected to the mast. The battery box can be removed from the mast before lifting the mast out of the base.

The battery box hangs unsupported on the mast. It is kept in position by the plugs, so never turn the mast upside down when there are no plugs connected to the mast.

3.02 How to transport the hoist?

The hoist can be dismantled for transport and storage, see section 3.1.

3.03 How to package the hoist for transport?

Guldmann recommends that the dismantled hoist is always transported in its original packaging.

4.00 Maintenance and storage

4.01 Cleaning the hoist

Hoist and lifting hanger can be cleaned using a damp sponge. If the hoist is dismantled and the battery box removed, the hoist can be washed using a soft brush and soapy water.

The hoist should always be thoroughly wiped after washing.

Do not use chemicals or autoclaving to cleanse the hoist.

The charger must only be wiped using a dry cloth.

4.02 Storing

The hoist should be kept in a dry room, where the humidity does not exceed 70 per cent. This is why the hoist must never be kept in bathrooms and similar areas.

4.03 Long-term storage

The hoist should be stored in cool rooms e.g. a basement.

The hoist should be stored at temperatures between 15 and 25° C due to the risk of running the batteries down. These can, however, be recharged.

Guldmann Service Team recommends that the hoist is connected to the charger during long-term storage.

4.04 How to prevent/avoid corrosion?

The hoist should not be kept/remain in damp surroundings for long periods of time. Water vapour might liquefy into water on the hoist, thus causing corrosion/rust in bearings as well as in the tubular steel frame.

The hoist should not be exposed to sudden cold or warmth. This means that one should not take a cold hoist into e.g. a hot bathroom.

In swimming baths and bathrooms where strong gasses may be present, the hoist is particularly exposed to corrosion and should always be removed from such places after use.

4.05 Maintenance which should be carried out by the owner?

The two fixing points of the actuator as well as the spindles of the width adjustment motor on mobile hoist GL3 should be lubricated using thin lubricating oil every six months or as required.

5.01**Life span and servicing of hoist**

According to the international standard EN/ISO 10535 "Hoist for the transfer of disabled persons - Requirements and test methods" a safety inspection of the hoist must be performed at least once a year.

The hoist has an expected life span of 15 years. Its life span is estimated on the basis of correct use, cleaning and maintenance, plus annual service checks and maintenance carried out by qualified service engineers of the Guldmann Service Team.

The hoist must then be assessed by qualified service staff as to its future use.

The hoist is controlled by a microprocessor PC board which can be damaged if it is being touched without the necessary measures. Therefore the electronics must only be serviced by qualified technicians.

Spare parts lists and drawings are available from manufacturer or supplier.

5.02**Battery and fuses**

Change of batteries and fuses should be carried out by a service engineer or by the Guldmann Service Team.

- 1 **Does the green lamp on the hoist light up when the hand control is activated?**
 Yes see point 3
 No see point 2
- 2 **Is emergency stop activated?**
 Yes turn emergency stop in the direction of the arrow and press twice on the hand control
 No see point 3
- 3 **Is the connector for the lifting motor fitted?**
 Yes see point 4
 No fit connector
- 4 **Is the connector for the hand control fitted?**
 Yes replace hand control
 No fit connector
- 5 **Is width adjustment of the legs malfunctioning?**
 Yes see point 7
 No see point 6
- 6 **Is the connector for the gear motor fitted?**
 Yes replace hand control
 No fit connector
- 7 **Has lift speed reduced?**
 Yes see point 8
- 8 **Does the lamp on the charging unit light up when it is connected/does the green lamp on the hoist blink?**
 Yes recharge hoist
 No replace charging unit and batteries if necessary

If the fault cannot be corrected using the information above, please call the Guldmann Service Team.

Service check of the mobile hoist – Allround

During the inspection a service report shall be made, describing what has been checked and exchanged.
 Worn or defective parts shall be replaced by new spareparts from V. Guldmann A/S.

- 1 **Visual check of the product**
 - Check the product for wear and tear
 - Check the product for any deformity
 - Check that the product does not show any other deficiencies.

2 Lifting motor/actuator

- Check spline ring integrity, lifting the boom gently until end stop is detected.
- According to the manufacturer's instructions the lifting motor/actuator shall be exchanged after 11.000 cycles or at least every 5 years.

3 Test of the product, as during normal use

- Check all functions on the product, with and without load, (I.e. Up, down, forward, backward, out and in).
- Check the emergency lowering is operational.
- Check the emergency stop is operational.
- Check the charging indicator is operational.

4 Dismantle the cover/fence

5 Check the electrical condition of the products

- Check the batteries and measure the:
 - Input/Voltage
 - Output/Voltage
- Check electrical functions and signals
- Check all wirings for errors and defects
- Check wire lead-ins
- Check all possible connections, plugs etc.

6 Check the mechanical condition of the product

- Clean the product for dirt and other impurities
- Inspect and evaluate the vital parts of the product
- Exchange defective and worn parts of the product
- Check and tighten all moving parts
- Grease the product.

7 Mount the cover/fence

8 Point 3 is carried out one more time as a control function

9 Have new errors or problems arisen in point 7?

- If new problems have arisen, go back to point 3
- If no problems have arisen, finish the inspection.

10 When a service inspection including service work or exchange of components has taken place, the final check should comprise a weight test with the product's nominal load.

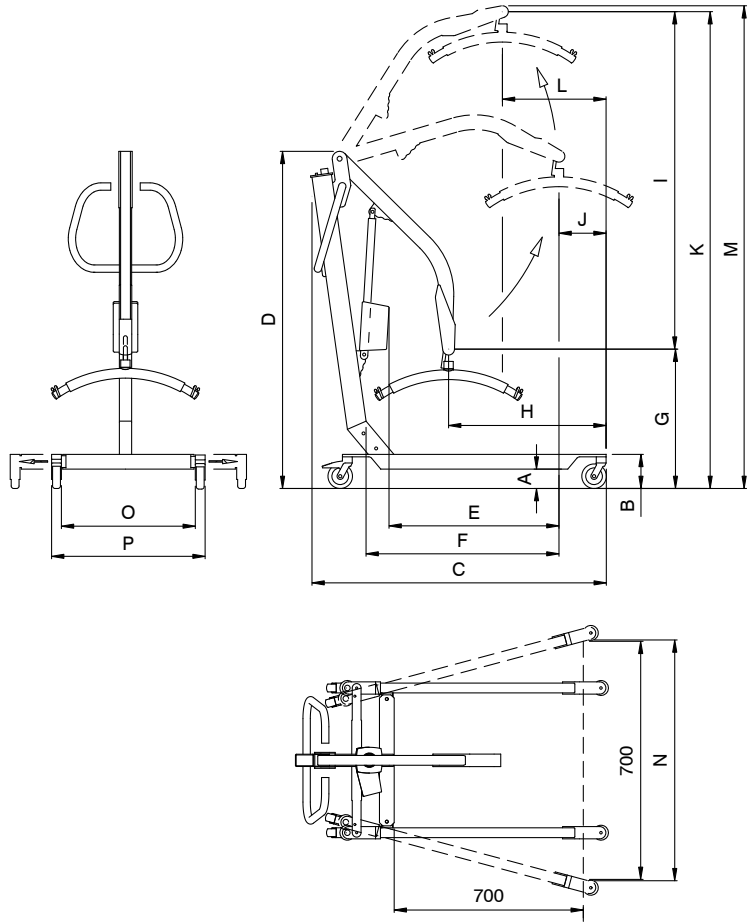

A.....	75 mm*	I.....	1085 mm
B.....	143 mm*	J.....	265 mm
C.....	1232 mm	K.....	1890 mm*
D.....	1377 mm*	L.....	440 mm
E.....	658 mm	M.....	1915 mm*
F.....	720 mm	N.....	720 mm
G.....	805 mm*	O.....	550-960 mm
H.....	463 mm	P.....	670-1080 mm

* If wheels Ø 80 mm are used, deduct 20 mm.
 If wheels Ø 50 mm are used, deduct 59 mm

Lifting capacity GL2, 3 and 4 150 kg
Lifting capacity GLHD 200 kg

Mobile hoist GL2 and 3, min. and max.
dimensions for angling of chassis, external. 670 to 1070 mm
Mobile hoist GL4, min. and max.
dimensions for angling of chassis, external. 560 to 860 mm

Mobile hoist GL2, 3 and 4 turning radius
at min. and max. leg settings. 1285 and 1335 mm

Hand control:
Operating power on pushbutton 2,6 N

Weight

Mobile hoist GL2 incl. lifting hanger excl. lifting sling 42.0 kg
Mobile hoist GL3 incl. lifting hanger excl. lifting sling 43.0 kg
Mobile hoist GL4 incl. lifting hanger excl. lifting sling 47.0 kg

Mobile hoist GL2 - chassis 16.5 kg
Mobile hoist GL3 - chassis 17.5 kg
Mobile hoist GL4 - chassis 22.5 kg
Mast and lifting boom incl. battery case 22.5 kg
Lifting hanger 2.0 kg

Sound level acc. to 3746

Lifting motor 48 dB(A)

Protection class

Mobile hoist IP 32
Hand control. IP 20
Microswitches of hand control IP 67

Electrical data

Connection between charging unit and Mobile hoist. 24V DC
Consumption/power of actuator. 180 VA
Charging unit, fully automatic 230V/115 V, 24V DC/340mAh
Charging time. Max. 8 hours
Batteries, sealed and maintenance free 4 pcs. 12V/2.1 Ah

Safety functions

Battery protection for
insufficient voltage Yes, disconnects
if voltage is insufficient

Permissible connection time
(work/break in percentages) 10/90



Guldmann™

EC-DECLARATION OF CONFORMITY

Manufacturer V. Guldmann A/S
 Graham Bells Vej 21-23A
 DK-8200 Aarhus N
 EAN country code: 57
 EAN distribution No.: 07287
 Phone +45 8741 3151
 Fax +45 8741 3131

Representative Company _____
 Address _____
 Country _____
 Phone _____

Hereby declare that Product **Guldmann Mobile Hoist GL2, GL3 & GL4**
 Type No. **XXXXX-YYYY-ZZZZ^{x)}**

^{x)} XXXXX: Reference No. of the product, YYYY: Serial No. of the product in the production year, ZZZZ: Production year

was manufactured in conformity with the provisions in according to the Council Directive 93/42/EEC of 14. June 1993 Class 1

- EN 10535: Hoists for the transfer of disabled persons
 - requirements and test methods
- EN 60601-1-1: Medical electrical equipment
 - Part 1-1: General requirements for safety
- EN 60601-1-2: Medical electrical equipment
 - Part 1: General requirements for safety
 - 2: Collateral standard: Electromagnetic compatibility

Skejby, 11.08.2009

Place and day of issue _____

Product responsible _____ Technical Manager

| Time to care |

V. Guldmann A/S

Corporate Office:
Graham Bells Vej 21-23A
DK-8200 Århus N
Tlf. +45 8741 3100
Fax +45 8741 3131
info@guldmann.com
www.guldmann.dk

Guldmann Inc.

5525 Johns Road
Suite 905
Tampa, FL 33634
Tel. 800 664 8834
Tel. 813 880 0619
Fax 813 880 9558
info@guldmann.net
www.guldmann.net

